

SalvisLab Cleaners – Quiet and efficient



About SalvisLab.

Swiss tradition with a great future

Renggli AG, founded in 1927, is an established Swiss family enterprise with international orientation in the realm of complete laboratory solutions. As one of the leading European manufacturers and market leaders in Switzerland, Renggli designs and implements state-of-the-art laboratories for research, industry, medicine and education.

With the renowned SalvisLab trademark, Renggli AG develops and produces a range of forced air drying ovens, incubators, vacuum drying ovens, heating cabinets, glassware cleaners and the corresponding accessories for each appliance. SalvisLab products are distributed world-wide through our international network of dealers.

We design professional equipment systems for you

SalvisLab develops and distributes high-quality laboratory equipment in close collaboration with the complete laboratory solutions provider Renggli AG in Rotkreuz. SalvisLab sets standards in quality, design and the production of laboratory equipment. New developments undergo intensive testing in our Development Center, so that they meet our customers' requirements.

The comprehensive range of equipment offered by SalvisLab provides extensive coverage of requirements in the laboratory field with forced air drying ovens, incubators, vacuum drying ovens, heating cabinets, glassware cleaners and the corresponding accessories for each appliance.

With our well-trained team, we offer you comprehensive advice on our equipment as well as reliable on-site service. Our collaboration with partners means there is an extensive global network to meet all needs in the laboratory field and we are also in a position to provide you with support extending beyond individual items of equipment, both as a consultant and an intermediary.

Our Core Competences

Counselling Competence

Our laboratory experts are eager to support you in all facets of laboratory technology. They will advise you accurately on all pertinent norms, legal provisions and safety aspects.

Planning and Engineering Competence

Our specialists are at your disposal to carry out the planning of the entire project. They even cover the engineering part, from media supply of the individual work place all the way to interfacing with the building control systems.

System Competences

In addition to being a dependable supplier of laboratory installations and equipment, we are your comprehensive one-stop service for counselling, planning/engineering, production, installation and maintenance/service. This is the key and guarantee for decades of perfect performance of your laboratories.

SalvisLab SC 1160.



The laboratory glassware cleaner is designed as built-in under sink or as free standing model. Efficient washing with jet pipe racks on two levels at the same time is possible.

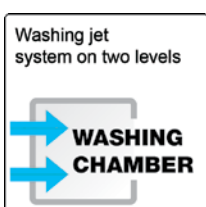

Key features

- LCD display
- 20 basic and 20 customisable washing programs for laboratory glassware
- Washing with jet pipe racks on two levels at the same time
- Built-in water softener
- Washing and rinsing temperature are fully adjustable up to +93 °C
- Temperature is monitored by two independent probes (PT-1000)
- Serial Interface RS 232
- Telescopic bearing rails
- Strong washing pump ensures identical spray pressure on both levels
- Inner and outer chamber, washing arms and tank filters are made of high quality stainless steel AISI 316L/DIN 1.4404
- Triple water filter to protect the washing pump
- Two automatic dosing pumps for liquid detergent
- The baskets and jet pipe racks from SC 1160 are fully interchangeable with our models SCD 1160, SCD 1190, SCD G60 and SD 1060

Connections

Power connection	400V/3 Ph/50 Hz
Power total	5600 W
Noise emission	52dB(a)
Permitted room temperature	+5 °C/+40 °C

Washing chamber

Chamber volume	171 l
Loading capacity	151 l

Dimensions

External dimensions (wxhxd) in mm	600x850x630
Internal dimensions (wxhxd) in mm	540x550x510

Accessories

Stand with boiler to pre-heat DI water, which reduces the washing time.

Optional

Power connection	230V/1 Ph/50 or 60 Hz
Additional liquid dosing pump	
Viewing window in door	
Booster pump for DI water	

Level positions

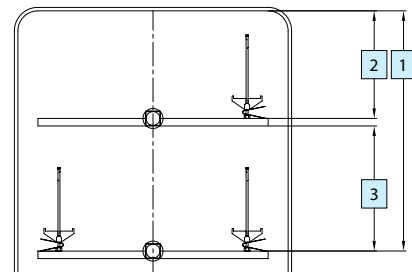

1. 440 mm
2. 170 mm
3. 210 mm

SalvisLab SCD 1160/G60.



The laboratory glassware cleaner and air jet drying system is designed as built-in under sink or as free standing model. Simultaneous washing or drying on two levels with jet pipe racks is possible.



16A01051
SCD 1160



16A01071
SCD G60

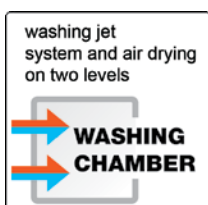

Key features

- LCD display
- 20 basic and 20 customisable washing programs for laboratory glassware
- Washing or drying with jet pipe racks on two levels at the same time
- Filtered air for jet pipe drying (Airfilter Class 5F)
- Built-in water softener for cold water
- Steam condenser
- Washing and rinsing temperature are fully adjustable up to +93 °C
- Temperature is monitored by two independent probes (PT-1000)
- Serial interface RS 232
- Telescopic bearing rails
- Strong washing pump ensures identical spray pressure on both levels
- Inner and outer chamber, washing arms and tank filters are made of high quality stainless steel AISI 316L/DIN 1.4404
- Triple water filter to protect the washing pump
- Two automatic dosing pumps for liquid detergent
- The baskets and jet pipe racks from SCD 1160/G 60 are fully interchangeable with our models SC 1160, SCD 1190 and SD 1060

Connections

Power connection	400V/3 Ph/50 Hz
Power total	5600 W
Noise emission	56 dB(a)
Permitted room temperature	+5 °C/+40 °C
Air capacity of dryer	150 m ³ /h
Power rating dryer	1400 W

Washing chamber

Chamber volume	171 l
Loading capacity	15 l

Dimensions

External dimensions (wxhxd) in mm	600x850x630
Internal dimensions (wxhxd) in mm	540x550x510

Accessories

Stand with boiler to pre-heat DI water, which reduces the washing time.

Optional

Power connection	230V/1 Ph/50 or 60 Hz
Additional liquid dosing pump	
Viewing window in door	
HEPA (H14) airfilter	
Booster pump for DI water	

Level positions

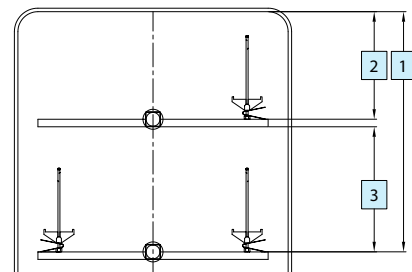

1. 440 mm
2. 170 mm
3. 210 mm

SalvisLab SCD 1190.



The laboratory glassware cleaner and air jet drying system which includes a storage compartment for liquid detergent is designed as built-in under sink or as free standing model. Simultaneous washing or drying on two levels with jet pipe racks is possible.



16A01052

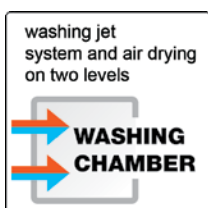

Key features

- LCD display
- 20 basic and 20 customisable washing programs for laboratory glassware
- Integrated storage compartment for liquid detergent
- Washing or drying with jet pipe racks on two levels at the same time
- Filtered air with forced jet pipe drying (Airfilter Class 5F)
- Built-in water softener for cold water
- Steam condenser
- Washing and rinsing temperature are fully adjustable up to +93 °C
- Temperature is monitored by two independent probes (PT-1000)
- Serial Interface RS 232
- Telescopic bearing rails
- Strong washing pump ensures identical spray pressure on both levels
- Inner and outer chamber, washing arms and tank filters made of high quality stainless steel AISI 316L/DIN 1.4404
- Triple water filter to protect the washing pump
- Two automatic dosing pumps for liquid detergent
- The baskets and jet pipe racks from SCD 1190 are fully interchangeable with our models SC 1160, SCD 1160, SCD G60 and SD 1060

Connections

Power connection	400V/3 Ph/50 Hz
Power total	5600 W
Noise emission	56 dB(a)
Permitted room temperature	+5 °C/+40 °C
Air capacity of dryer	150 m ³ /h
Power rating dryer	2000 W

Washing chamber

Chamber volume	171 l
Loading capacity	15 l

Dimensions

External dimensions (wxhxd) in mm	900x850x630
Internal dimensions (wxhxd) in mm	540x550x510

Accessories

Stand with boiler to pre-heat DI water, which reduces the washing time.

Optional

Power connection	230V/1 Ph/50 or 60 Hz
Additional liquid dosing pump	
Viewing window in door	
HEPA (H14) airfilter	
Built-in printer	
Booster pump for DI water	

Level positions

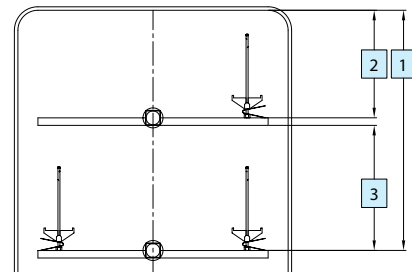

1. 440 mm
2. 170 mm
3. 210 mm

SalvisLab SCD G650.



SalvisLab SCD G650 glassware washer is a larger model, frontal loading, with HEPA-filtered forced air drying, four washing/drying positions and three washing/drying levels. This machine can be used also to clean large bottles (20, 50, 60 l). The HEPA-filtered forced air drying system with adjustable time and temperature setting, helps to ensure a complete drying, inside and outside, of all the glassware.

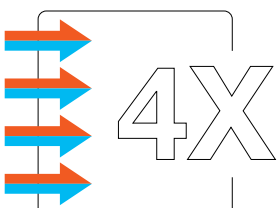

16A01028

Key features

- LCD color display
- 20 standard programs for laboratory glassware and 20 additional custom programs available for customization
- USB connection
- RS 232 port for printer connection to monitor and validate washing phases
- Ergonomic design of the door level
- Telescopic bearing rails enable easy and safe loading/unloading of the glassware
- Washing/drying jet system on four levels
- Inner cabinet, washing arms and tank filters made of high quality stainless steel AISI 316L/DIN 1.4404
- Heavy washing pump ensures high flow rate combined with effective spray pressure
- Built-in drain pump
- Triple water filtering system captures residue preventing re-circulation and extending the pump life
- Washing and DI disinfection temperature are fully adjustable up to 93 °C/199 °F. Temperature is monitored by two independent sensors
- Built-in water softener
- HEPA-filtered forced hot air drying system with adjustable time and temperature setting
- Standard steam condenser eliminates vapors from entering into the laboratory
- Three standard automatic liquid dispensers provided with level control. One more dispensers are available
- Possibility to store up to four Labopur five l containers into the basement
- SalvisLab SCD G650 accepts a variety of jet baskets
- Light inside the chamber

Connections

Power connection	400V/3~+N/50 Hz
Power total	8250 W
Pump power	750 W
Noise emission	57.5 dB(a)
Permitted room temperature	+5 °C/+40 °C
Dryer blower	250 m ³ /h
Dryer heating	4000 W

Washing chamber

Chamber volume	250 l
Loading capacity	220 l

Dimensions

External dimensions (wxhxd) in mm	650x1860x750
Internal dimensions (wxhxd) in mm	650x690x585

Optional

Power connection	230V/3 Ph/50 or 60 Hz
4th Chemical dosing pump	
Ethernet connection	
Boiler to pre-heat DI water	
Booster pump for Demi water	
Conductivity Sensor	
Flowmeter for chemical control	

Level positions

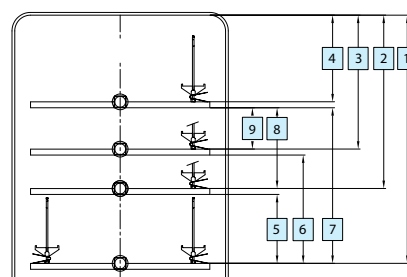

1. 630 mm*	5. 170 mm
2. 440 mm	6. 270 mm
3. 340 mm	7. 390 mm
4. 220 mm	8. 200 mm
	9. 100 mm

*The usable height of the wash level is reduced by 40 mm per wash floor with the use of basic baskets with rotating arm.

SalvisLab SD 1060.

The laboratory glassware dryer is designed as built-in under sink or as free standing model. It is an ideal completion with the SC 1160.

Key features

- LED display
- Editable air drying programs
- Drying with jet pipe racks on two levels at the same time
- Jet drying with filtered air pressure (Airfilter Class 5F)
- Two heating elements with 750 w each
- Temperature is monitored by two independent probes (PT-1000)
- Serial Interface RS 232
- Telescopic bearing rails
- Inner and outer chamber are made of high quality stainless steel AISI 316L/DIN 1.4404
- The baskets and jet pipe racks from SD 1060 are fully interchangeable with our models SC 1160, SCD 1160, SCD G60 and SCD 1190



16A01070

Connections

Air exhaust	ø 60 mm
Power connection	230V/50 Hz
Power total	2000 W
Noise emission	52 dB(a)
Permitted room temperature	+5 °C/+40 °C

Washing chamber

Chamber volume	171 l
Loading capacity	151 l

Dimensions

External dimensions (wxhxd) in mm	600x850x630
Internal dimensions (wxhxd) in mm	540x550x510

Level positions

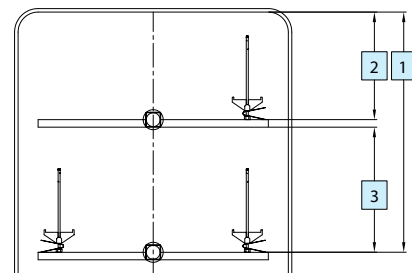

1. 440 mm
2. 170 mm
3. 210 mm

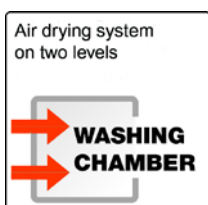

Baskets.

SC 1160, SCD 1160, SCD 1190, SCD G60, SD 1060

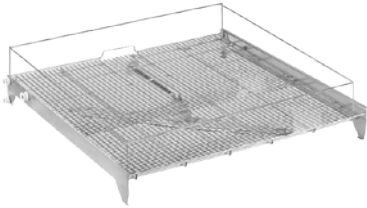

16F01530
Upper washing cart with washing arm

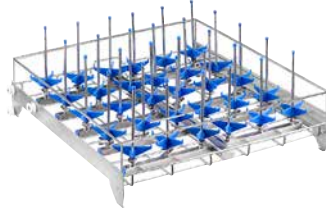

16F01505
Top jet pipe rack, 25 jets (h 140/170 mm, ø 6 mm)

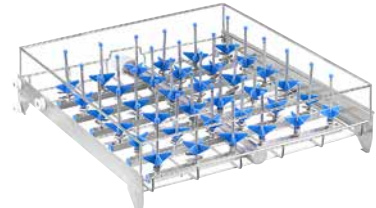

16F01500
Top jet pipe rack, 36 jets (h 80/110 mm, ø 6 mm)

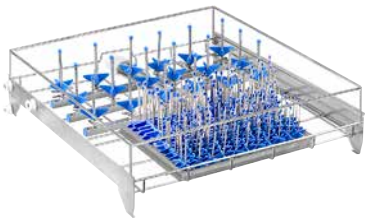

16F01503
Top mixed jet pipe rack for centrifuge tubes, vials, test tubes with 121 positions and 18 jet pipes. (h 140/170 mm, ø 6 mm)



16F01531
Lower washing cart

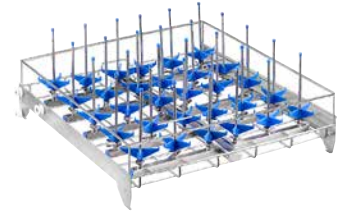

16F01501
Lower jet pipe rack, 25 jets (h 140/170 mm, ø 6 mm)



16F01506
Lower jet pipe rack, 36 jets (h 75/110 mm, ø 6 mm)



16F01534
Lower pipettes washing cart. Max. 48 positions. (l 250/300 – 535 mm)

Inserts for basic baskets.

SC 1160, SCD 1160, SCD 1190, SCD G60, SCD G650, SD 1060



16F01550
Insert with 28 spring hooks for
laboratory glassware



16F01551 16F01552
Grid basket Cover (for grid
120x120x120 mm basket 16F01551)



16F01553
Insert for max. 30 petri dishes
(for lower basic basket)
240x80x430 mm



16F01555 16F01554
¼ insert (100 mm h) ¼ insert (200 mm h)

16F01556 16F01557
¼ insert (130 mm h) Cover

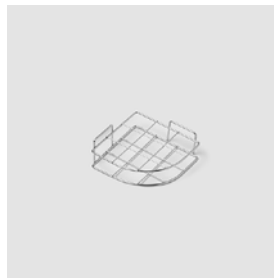

16F01558
Separator for ¼ insert



16F01561
Support grid
to have a flat
surface on a
16F01530.
Please note this
will reduce the
usable height



Jets.

SC 1160, SCD 1160, SCD 1190, SCD G60, SCD G650, SD 1060



16F01252
Jet support
ø 6 mm,
h 140 mm

16F01253
Jet support
ø 6 mm,
h 186 mm



16F01286
Gasket for
pipette ø max.
14 mm, min.
4 mm, ø 20 mm,
h 21 mm

16F01277
Cap



16F01287
Gasket for pipette
ø 25 mm,
h 13 mm

16F01277
Cap



16F01248
Jet bottle
support ø 6 mm,
h 200 mm

16F01249
Jet bottle
support ø 6 mm,
h 130 mm

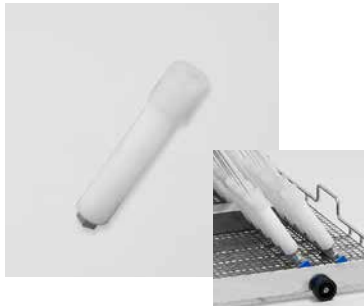

16F01269
Jet sleeve with silicone guard for
pipettes
(max. pipettes ø 11 mm)



16F01233
Plastic cross
ø 75 mm for
jet ø 6 mm

16F01240
Jet cap ø 10 mm
for jet ø 6 mm



16F01230
Plastic cross
ø 32 mm for
jet ø 2,5 mm

16F01238
Jet cap ø 4 mm
for jet ø 2,5 mm



16F01231
Plastic cross
ø 54 mm for
jet ø 4 mm

16F01239
Jet cap ø 5 mm
for jet ø 4 mm



16F01220
Bottle support
ø 28 mm for
jet ø 6 mm

16F01222
Bottle support
ø 45 mm for
jet ø 6 mm

16F01242
Plastic cross
ø 15 mm for
jet ø 2,5 mm

16F01221
Bottle support
ø 33 mm for
jet ø 6 mm

Baskets.

SCD G650



16F01032
Upper washing cart with washing arm, loading space 485x450 mm



16F01087
Lower pipettes washing cart 56 pipettes
Minimum pipette (l 250/300 – 535mm



16F01033
Lower washing cart

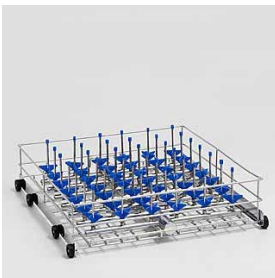

16F01035
Lower jet pipe rack, 42 jets

16F01034
Upper jet pipe rack, 42 jets



16F01085
20l bottle and big capacity Erlenmayer flasks washing cart

16F01086
5l and 10l bottle and big capacity Erlenmayer flasks washing cart

Recommended by SalvisLab.

LaboPur offers series of cleaners for laboratory & glassware washing machines, which covers the range from universal cleaner to highly efficient detergent. The complete product overview of LaboPur is available online, orders can be placed directly at the online shop www.labopur.ch



DES 1000



ASSA



DES 2000 Forte

4 steps guide.

Washing cart selection guide

- 1** Choose the glassware washing system
- 2** Select the washing cart frame
 - maximum glassware diameter accepted and related number of glassware positions
 - upper or lower level
- 3** Select the jets
 - choose the jet type
 - choose the jet height
- 4** Check the useful heights of the machine levels

1 Choose the glassware washing system

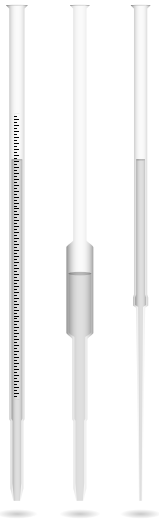

Bulb, graduated,
Pasteur pipettes

Jet washing

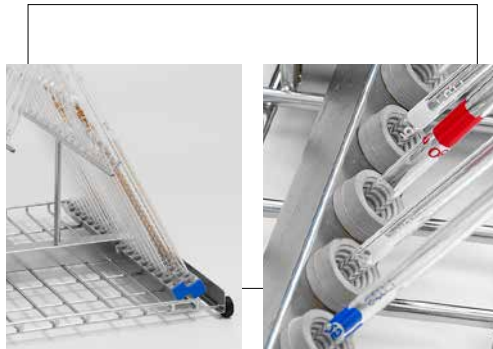

Immersion and flushing washing

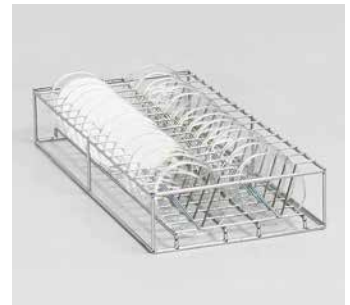

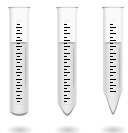

Test tubes and vials



Low capacity volumetric flasks



Centrifuge tubes



Volumetric flasks narrow neck

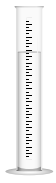

Graduated cylinders



Wide neck bottles



Erlenmeyer flasks wide neck



Erlenmeyer flasks narrow neck



Flat or round bottom flask narrow neck



Funnels

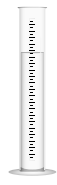

Graduated cylinders



Erlenmeyer flasks wide neck



Wide or narrow neck bottles



Weighing bottles

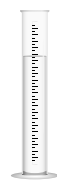

Graduated cylinders



Imhoff cones



2 Select the washing cart frame

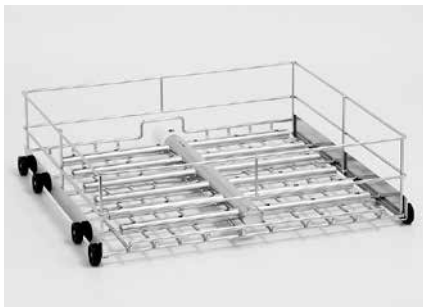

Empty version of the racks give the customer the possibility of full configuration. The tables show the maximum glassware diameter allowed in the washing cart frame and dof the number related positions.

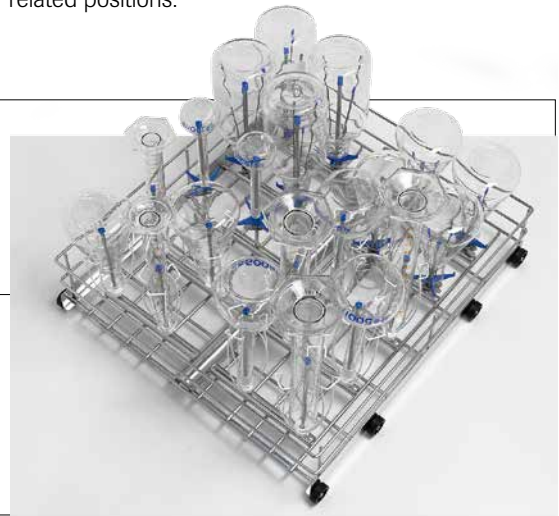

It is possible to customize the washing cart.

SC 1160, SCD 1160, SCD 1190, SCD G60, SD 1060

Empty rack code	ø max mm	No. of jets	Upper level Lower level	Notes
16F01518	25	156	U	ø 2,5 mm jets only
16F01519	40	110	U	ø 2,5 mm jets only
16F01512	50	64	U	ø 2,5 mm jets only
16F01515	57	56	U	ø 2,5 – 4 mm jets only
16F01509	74	36	U	
16F01510	90	25	U	
16F01520	105	18	U	
16F01521	40	110	L	ø 2,5 mm jets only
16F01511	50	64	L	ø 2,5 mm jets only
16F01522	56	56	L	ø 2,5 – 4 mm jets only
16F01523	70	39	L	
16F01507	70	36	L	
16F01508	89	25	L	
16F01524	105	18	L	
16F01525	110	16	L	
16F01526	150	9	L	
16F01514	62	18	L	250x490 mm free
16F01513	70	12	L	290x490 mm free
16F01527	89	10	L	265x490 mm free
16F01516	89	10+121	L	

SCD G650

Empty rack code	ø max mm	No. of jets	Upper level Lower level	Notes
16F01151	32	156	U	ø 2,5 mm ø jets only
16F01145	40	110	U	ø 2,5 mm jets only
16F01146	35	84	U	ø 2,5 mm jets only
16F01044	70	42	U	
16F01105	100	20	U	
16F01152	110	16	U	
16F01153	20	121	U	200x490 mm free
16F01154	75	24+121	U	
16F01155	25	121	U	ø 2,5 mm jets only
16F01156	25	121	L	ø 2,5 mm jets only
16F01157	40	110	L	ø 2,5 mm jets only
16F01158	60	56	L	ø 2,5 – 4 mm jets only
16F01037	70	42	L	
16F01104	100	20	L	
16F01159	110	16	L	
16F01161	130	12	L	
16F01162	70	24	L	230x490 mm free
16F01163	100	12	L	220x490 mm free
16F01164	75	24+121	L	

3

Select the jets

	16F01400	16F01414	16F01424	16F01399	16F01425
A mm	2,5	2,5	2,5	2,5	2,5
B mm	4	4	4	4	4
C mm	15	15	32	32	32
D mm	80	80	50	80	155
E mm	75	75	30	60	135

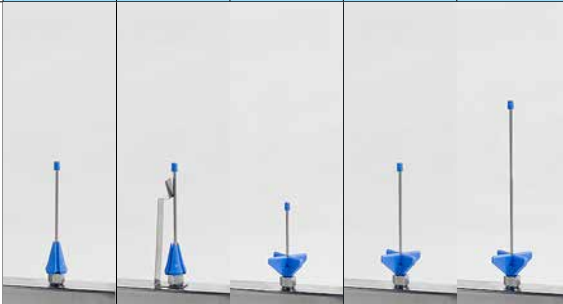

Jets

Jets are available in different height sizes. According to the glassware shape and dimension, jets should be chosen in order to have 10/90 mm clearance from the jet final tip and the glassware bottom. Some kind of jets are endowed with adjustable spring retainers. Spring retainers allow to place glassware of different heights on the same jet.

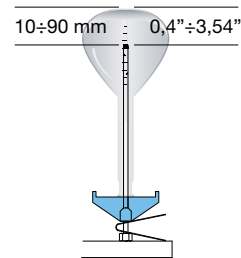

	16F01422	16F01407	16F01402
A mm	4	4	4
B mm	5	5	5
C mm	54	54	54
D mm	75	110	175
E mm	50	80*	130*



Jet dimension

The critical dimensions to be considered in choosing the suitable jet are the following:

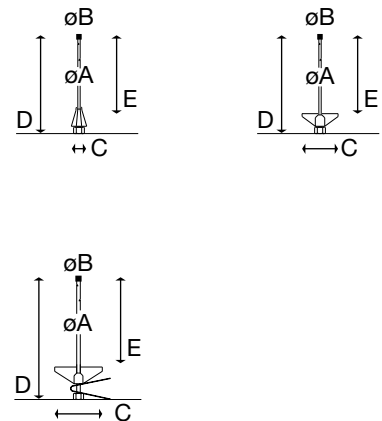

E=Dimension:
 For the correct coupling jet/glassware and the check of the distance jet/glassware
 D=Dimension+clearance:
 For the compatibility check washing machine/positioning level.

	16F01406	16F01405	16F01404	16F01403	16F01423
A mm	6	6	6	6	6
B mm	10	10	10	10	10
C mm	75	75	75	75	75
D mm	115	135	175	225	275
E mm	85	95*	130*	185*	235*



	16F01408	16F01412	16F01426
A mm	6	6	6
B mm	10	10	10
C mm	75	75	75
D mm	135	225	275
E mm	105	185*	235*

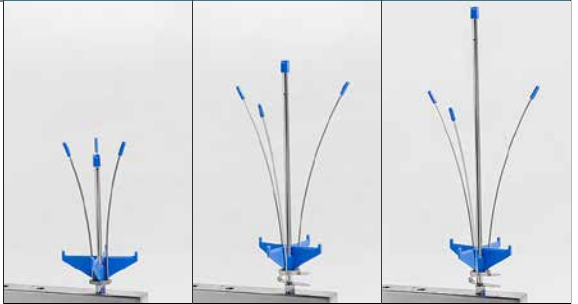

	16F01234	16F01235	16F01259	16F01236	16F01237
A mm	6	6	6	6	6
B mm	10	10	10	10	10
C mm	75	75	75	75	75
D mm	115	135	175	225	275
E mm	85	95*	130*	185*	235*

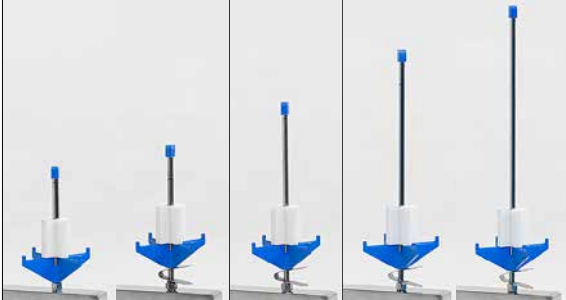

incl. ø 28 mm bottle support, code 16F01220.
Also available: ø 33 mm/45 mm

	16F01256	16F01257	16F01258
A mm	6	6	6
B mm	10	10	10
C mm	flex	flex	flex
D mm	175	225	275
E mm	-	-	-



4

Check the useful heights of the machine levels

Dimensions SC 1160, SCD 1160, SCD G60, SCD 1190

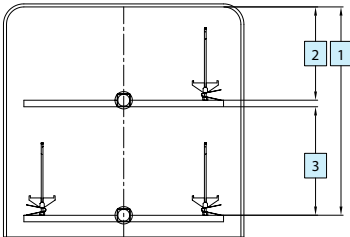

1. 480 mm
2. 210 mm
3. 250 mm

Dimensions SCD G60

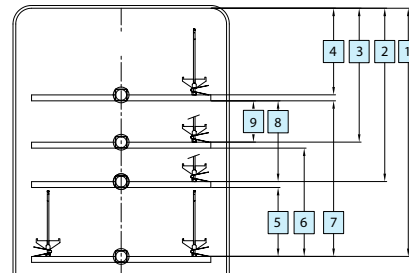

- | | |
|-----------|-----------|
| 1. 630 mm | 5. 170 mm |
| 2. 440 mm | 6. 270 mm |
| 3. 340 mm | 7. 390 mm |
| 4. 220 mm | 8. 200 mm |
| | 9. 100 mm |

Washing cart with washing arm

Washing cart level heights have to be reduced by 40 mm (L) for the SC1160, SCD1160, SCD1190 and SCD G60 models when the upper level washing cart is provided with a washing arm. The use of an upper level washing cart provided with washing arm allows 15 mm gain on loading useful height (G) referred to the washing cart loading area.

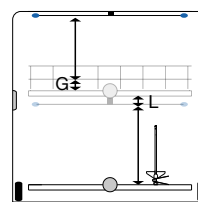

Important notice

Washing loads with glassware that are positioned too close to the washing arm jets can generate shadow areas where washing efficiency can be reduced.

Renggli AG
SalvisLab
Birkenstrasse 31
CH-6343 Rotkreuz
Switzerland
www.salvislab.com



salvisLAB

renggli

Laboratory
Systems